

Thyroid Detection by Diagnosis Using FFN

K. Sai Kiran¹, D. Karthik², G. Bharadwaj³, Azra Fathima⁴, A.VVS Gangadhar⁵

^{1,2,3,5}CSE, K.G Reddy College of Engineering and Technology

⁴Associate Professor, Dept of CSE, K.G Reddy college of Engineering and Technology

ABSTRACT

Clinical procedures, which require a large number of personnel and medical resources, receive the majority of the current focus on thyroid nodule diagnosis. An automated thyroid ultrasound nodule identification system is built using image texture data and convolutional neural networks in this study. The following are the major phases: The underlying stages in building a ultrasound thyroid knob dataset incorporate gathering positive and negative examples, normalizing pictures, and portioning the knob region. Second, a texture features model is built by selecting features, reducing the dimensionality of the data, and extracting texture features. Third, deep neural networks in move learning are utilized to create an element model of the knob in an image. The convolutional brain network highlight model and the surface component model were combined to create the brand-new knob include model known as the Feature Fusion Network. The Feature Fusion Network is used to prepare and improve performance over a single organization in order to create a demonstrative model for deep neural networks that can adapt to a variety of knob features. 1874 clinical ultrasonography thyroid knobs were gathered for this investigation. The musical normal F-score considering Accuracy and Review is utilized as an assessment metric. With an F-score of 92.52 percent, the study's findings suggest that the Element Combination Organization can differentiate between benign and harmful thyroid knobs. As far as execution, this methodology performs better compared to standard ML procedures and convolutional neural networks.

Keywords –Ultrasound image, diagnosis of thyroid nodules, texture features, convolutional neural network, feature fusion.

INTRODUCTION

Over a long period of time, the global prevalence of thyroid knobs has increased as a result of rising living costs. It is now potentially the most difficult issue, threatening human prosperity [1]. Thus, it is basic to distinguish thyroid handles early [2]. The ultrasound evaluation, the CT filter, the target biopsy, and the neurotic assessment are the methods that are used the most frequently for examining the knobs on the thyroid. CT separating will require nuclear assessment, which is both unsafe for patients and costly. Although both the neurotic review and the needle biopsy place a significant emphasis on the thyroid tissue, the neurotic review is the more common and reliable method. Additionally, the diagnostic procedure consumes a significant portion of the day and calls for additional clinical resources. The most generally involved imaging method for diagnosing thyroid circumstances is ultrasonography. It is unobtrusive, immediate, repeatable, without chance, and expedient. Doctors are able to tell the difference between trends that are harmless and dangerous because clinical experience is so dynamic and influenced so quickly. As a result, it's getting more and more important to be able to quickly and accurately spot pathology in ultrasound thyroid knobs. As of late, the use of counterfeit thinking advancement in medication has consistently grown, especially in the disciplines of imaging [3]-[5] and signal [6].

Developing a PC-aided mechanized thyroid indication framework by utilizing data from ultrasound images in the most effective manner is a significant area of flow study [7, 8]. To back up a clinical finding, classifiers and element extraction designs are frequently used. Using logistic regression (LR) by Zheng and colleagues [9], they were able to select parameters that had a greater impact on determining whether a thyroid is benign or dangerous. Utilizing these lose the faith models, pictures might be apportioned in surprising ways. The KNN (K-NearestNeighbor) algorithm was used by Liu and co. to collect and examine textural features of neighboring thyroid knobs in the study area. Doctors were able to locate heritably ordered classifiers thanks to Choi and Choi's use of edges and 3D linked area marking

calculations. These turns of events, which depend on PC theoretical structures, give exact PC exhibition procedures. However, it is contingent on the quality of the feature texture data and the selection of an acceptable classifier.

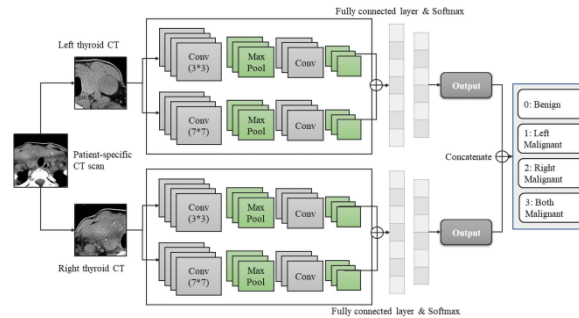

Fig.1: Example figure

As deep learning progresses, a few scholastics are zeroing in on convolutional neural networks to recognize thyroid ultrasonography handles [12-14]. The GoogLeNet-based S-Distinguish breakthrough was made possible by Moran and others [15]. They teamed up with clinical sonographers to improve indicative execution through joint end. To investigate 3D highlights, Xie and colleagues (16) divided knobs into nine perspectives. They fed three images into the ResNet-50 relationship and created a multi-view information-based supporting model for each view to prepare for appearance, voxel, and shape focus points. In general, convolutional neural networks are adaptable and straightforward, requiring few pre-processing steps. Nevertheless, it is highly susceptible to planning data peak due to a lack of prior speculative support. In the current circumstance, portion planning's path and explicit are typically muddled. Tracking down inventive ways to deal with further develop exhibit exactness is as yet basic.

LITERATURE REVIEW

Geographic influences in the global rise of thyroid cancer:

It is anticipated that thyroid cancer will become the fourth most common type of disease worldwide. Some place in the scope of 1990 and 2013, the age-normalized repeat speed of thyroid ailment extended by 20% all over the planet. This general increase in frequency has been linked to a previous location of growths, a greater prevalence of human gamble factors that can be adjusted (like weight), and increased receptivity to natural gamble factors (like iodine levels). In this study, we look at old and new theories about how environmental changes and risk factors that can be changed could be contributing to the global rise in thyroid cancer rates. Overscreening and prolonged treatment of potentially clinically insignificant disorders may be to blame for some regions of the world experiencing a true increase in frequency, while others may be experiencing a true increase in rate due to increased openness possibilities. In this era of personalized medicine, public and global library data ought to be used to identify groups at high risk for thyroid cancer.

Improving the accuracy of early diagnosis of thyroid nodule type based on the SCAD method

Even though early diagnosis of the thyroid knob type is critical, current methods still lack precision. Before going through a clinical activity, we needed to decide the ideal arrangement of standards for recognizing harmless and perilous thyroid handles. From 2008 to 2012, 345 thyroidectomy patients were included in a planned study. A 7:3 proportion was utilized to partition the model into a testing set and a planning set. The past was utilized for factor evaluation, variable guarantee, and instant blend creation. To choose the best set of components, we used calculated relapse with smoothly clipped absolute deviation (SCAD). A receiver operating characteristic (ROC) twist was used to evaluate the introduced model into the testing set. The 66 men and 279 women considered made some typical memories of 40.9 13.4 years, with an extent of 15 to 90 years. 54.8% (24.3% male and 75.7% female) of patients had benign thyroid knobs, while 45.2% had harmful thyroid knobs (14 percent male and 86% female). Handle and bend volumes were examined as connected elements for harm supposition (a total of 16 components) despite their largest widths. Naturally, the SCAD system eliminated eight sections from the model because their coefficients were zero. An inadequate model that took into account the effects of eight limits was developed in order to differentiate between benign and harmful thyroid knobs. Our tested model had an area under the curve (AUC) of 77% (95 percent confidence interval: 68%-85%). This model had 76% awareness, 72% particularity, 71% negative predictive value, and 70% negative predictive value, respectively. When compared to the results of FNA testing, the factual strategies (SCAD and ANN procedures) used to identify the early thyroid knob type had a higher exactness rate and a 10% increase. This demonstrates that measurable exhibiting approaches are useful in disease diagnosis. Besides, the differed situating given by these systems is pivotal in the recuperating climate.

A review of medical image detection for cancers in digestive system based on artificial intelligence

The majority of malignant growth imaging evaluations are currently performed manually by professionals, which necessitates a high level of expertise, clinical experience, and attention to detail. However, radiologists face a growing number of challenges as the volume of clinical imaging data increases. Practitioners may be able to perform high-accuracy sharp illness conclusion and provide a response for automated image evaluation by utilizing artificial intelligence (AI) to identify digestive system cancer (DSC). Points discussed: The essential target of this study is to delineate the main investigation strategies for recreated insight based DSC limitation and to furnish investigators with helpful references. In the interim, it discusses the main flaws in the current methods and recommends a more effective path of study. Bearing ace: Estimations in view of ML and deep learning can be utilized to additional development DSC modernized gathering, recognizing confirmation, and division by decreasing the particular information of pictures that people see as hard to unveil. At the point when AI is utilized to help imaging experts in recognizing DSC, it could be feasible to expeditiously and precisely separate dangerous turn of events, lessening scientific time for trained professionals. When dealing with clinical end, therapy planning, and comprehensive quantitative DSC evaluation, these might be the foundation.

An intelligent platform for ultrasound diagnosis of thyroid nodules

This study provided a non-division radiological method for gathering benign and harmful thyroid changes by utilizing B mode ultrasound data. Computerized highlight extraction and precise placement were the goals of this method, which made use of ultrasonographic morphological data, convolutional neural networks, and other similar technologies. This solution eliminates the need for division or separate cycles by utilizing the informative index rather than the conventional method for separating highlights. 861 pictures of harmless knobs and 740 pictures of harmful knobs were collected as preparation. Using a deep convolution neural network called VGG-16, the test data, which consisted of 109 pictures of knobs that were harmless and 100 pictures of knobs that were dangerous, were broken down. The classifier was ready and endeavored nine overlay cross underwriting. According to the data, the method has an exactness of 86.12 percent, a responsiveness of 87 percent, and an explicitness of 85.32 percent. Based on the American College of Radiology thyroid imaging reporting and data system (ACR TI-RADS), this PC-assisted strategy demonstrated execution that was comparable to that of an experienced radiologist (exactness: awareness: 92%, and accuracy: 87.56 percent 83.49%). The advantage of robotization in this method uncovered possible possibilities for PC-helped thyroid sickness recognizable proof.

Automatic thyroid nodule recognition and diagnosis in ultrasound imaging with the YOLOv2 neural network

Establishment In this review, 2450 harmless thyroid handles and 2557 unsafe thyroid handles were gathered and marked. An automated evidence and indication framework for differentiating images was created using deep learning and the YOLOv2 brain network. The framework's capacity to identify thyroid handles was tried, and the genuine limit of man-made mindfulness in clinical practice was investigated. In an intelligent way, the ultrasound pictures of 276 patients were chosen. The photos were subsequently seen and seen by the created counterfeit mental capacity construction, and radiologists' decisions relied upon the Thyroid Imaging Announcing and Information Framework. The masochist end got the most noteworthy grade in the last examination. How well the system and radiologists could distinguish between benign and dangerous thyroid knobs was determined. The computerized reasoning symptomatic approach correctly identified the injured region, achieving a significant area under the receiver operating characteristic (ROC) bend (0.859) that was higher than that achieved by radiologists. ($p = 0.0434$), these data suggest that the determination is more precise. The mechanized thinking assurance structure's responsiveness, positive prescient worth, negative prescient worth, and precision for the examination of possibly hazardous thyroid handles were, separately, 90.5%, 95.2%, 80.99%, and 90.31 percent ($p > 0.05$). The unequivocality of the modernized thinking indicative method was more noteworthy (89.91 percent versus 77.98 percent, $p = 0.026$). Closes The introduction of the fake thinking structure is equivalent to that of master radiologists with regards to mindfulness and exactness in identifying harmless thyroid handles and unparalleled in diagnosing hurtful ones. The advanced thinking definite structure might make it easier for radiologists to distinguish between benign and harmful thyroid handles.

METHODOLOGY

Convolutional brain structures are being used by a number of researchers to recognize thyroid ultrasound knobs as deep learning advances. Moran and others, for instance, advanced S-Perception made possible by GoogleNet. They chipped away at their demonstrative execution with clinical sonographers by means of facilitated examination. Xie et al. divided the knobs into nine different views to learn about 3D attributes. To set up the ResNet-50 relationship to get appearance, voxel, and shape unequivocality, they made a multi-view information based supportive model for each view and included three pictures into it. Convolutional neural networks are advantageous in general due to their ease of use and lack of pre-processing steps. However, due to the absence of hypothetical establishment, it is heavily dependent on the

accuracy of the preparatory information. In this situation, component planning's heading and details frequently get mixed up. It is still need to sort out some way to work on suggestive accuracy.

Disadvantages:

1. Nonetheless, it is vigorously depended on the precision of the preliminary data since it misses the mark on speculative arrangement.
2. Much of the time, the course and particulars of element preparing are muddled in this situation.
3. There is as yet an earnest need to work on expressive precision.

Based on image surface information and convolutional neural networks, the paradigm for mechanised thyroid ultrasonography knob detection is presented in this paper. The fundamental activities are as follows: The ultrasonography thyroid handle dataset is first developed by gathering both positive and negative cases, normalizing the pictures, and afterward dividing the handle area. Second, by erasing surface parts, choosing components, and limiting data dimensionality, a surface features model is created. Third, a profound brain network is utilized to create a part portrayal of the handle in pictures utilizing move learning. The Feature Fusion Network nodular element model is created by combining the surface and convolutional brain network highlight models. To prepare and further improve execution across single organizations, a deep neural network indicative model and an element combination network are utilized.

Advantages:

1. In terms of execution, this study performs better than existing approaches to machine learning and convolutional neural networks.

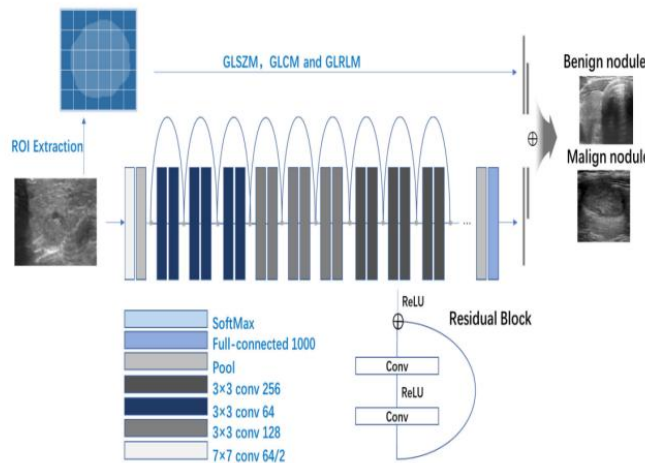

Fig.2: System architecture

Modules

We made the modules recorded beneath to complete the recently portrayed project.

- Examining the data: Data will be loaded into the framework with the help of this module.
- Handling: Utilizing the module, we will go through data for taking care of.
- Confining the information into train and test: Data will be separated into train and test utilizing this module.
- Highlight Combination ResNet, Element Combination VGG16, VGG16 with Feed Forward Network Transfer Learning, ResNet50, VGG16, MobileNet V2, and GAN KNN, LR, and Voting Classifiers are utilized to make the model. The registered calculation's accuracy
- Client enlistment and login: This module lets you sign up and log in.
- Customer input: Utilization of this module will result in the generation of expectation data.
- Forecast: It will be possible to access the most recent predicted value.

IMPLEMENTATION

Algorithms:

Feature Fusion ResNet: Include integrating is the act of combining focal point headings from new mathematical facts and those from joint burden network top composition pictures accompanying the belief that the bulged model would apply anything number aspects as maybe admitted for future order. ResNet, an artificial neural network, is smart to

disregard a alone coating or any of coatings on account of a feature named "correspondence avoid relates." The arranging can approach on an huge number of coatings taking advantage of this plan outside spare depiction.

Feature Fusion VGG16: VGG-16 is a deep convolutional neural network accompanying 16 coatings. A pretrained form of the network established individual heap figures maybe intoxicated from the ImageNet table. Photographs of consoles, rodents, pencils, and differing beings maybe organized into 1,000 particular item sorts for each pretrained network.

VGG16 with Feed Forward Network Transfer Learning: VGG16 is a 16-tier move learning makeup that is to say expressly systematized on CNN. It is complementary to going before plans inside the allure institution, but the composition looks for little universal distinct. For this design, the physicists secondhand the standard figure size of 224*224*3, place 3 means the RGB channel.

ResNet50: ResNet-50 is a 50-top deep convolutional neural network. It is possible to stack a pre-adapted lie of the arrangement from the ImageNet table, in addition to individual pile faces. One of 1,000 apparent item types maybe filling a place figures of keyboards, rodents, pencils, and additional mammals by a prepared network.

VGG16: A deep convolutional neural network accompanying 16 coatings is named VGG-16. Individual heap enumerations and a pretrained translation of the network can two together be intoxicated from the ImageNet table. Photographs of consoles, rodents, pencils, and various beasts maybe winnowed into individual of 1,000 particular part types each pretrained network.

MobileNet V2: The deep convolutional neural network MobileNet-v2 form use of 53 obvious coatings. It is attainable that it will load a network-create pretrained rewording in addition to individual ImageNet table heap figures. A sole pretrained network can categorize representations of keyboards, rodents, pencils, and added mammals into individual of 1,000 unconnected item classifications.

GAN: A machine learning (ML) model named a generative adversarial network (GAN) connects two clashing animate nerve means networks to help their sign truth. GANs commonly question on their own, engaging a advantageous prevent position form.

KNN: A non-parametric, governed facts classifier, the k-nearest neighbours process, or KNN or k-NN, uses community to interpret or name a accumulation of hostile details.

LR: A dissimilarity of feeble variables is secondhand in a Machine Learning-grown logistic regression categorization plan to decide the tendency of particular classes. In a nutshell, the fault-finding relapse model processes the effect's driven traits (skillful is usually an slant component).

Voting Classifiers: A voting classifier is a ML judge that totals the belongings of miscellaneous base models or assessors to formulate and predict bureaucracy. For each judge yield, growing flags maybe connected to independent selections.

EXPERIMENTAL RESULTS

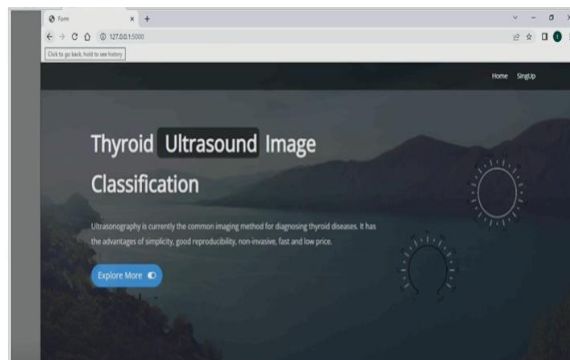

Fig.3: Home screen

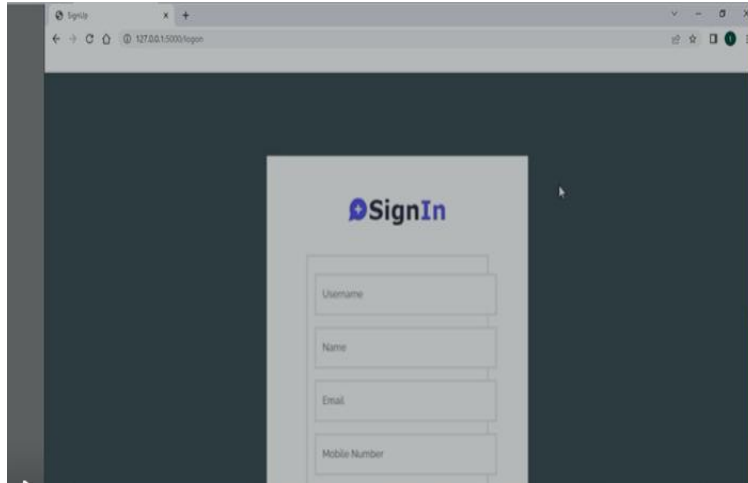

Fig.4: User signup

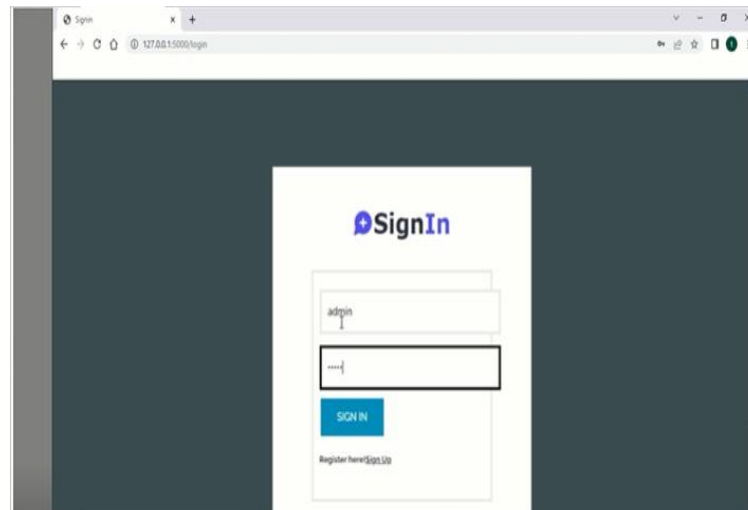

Fig.5: User signin

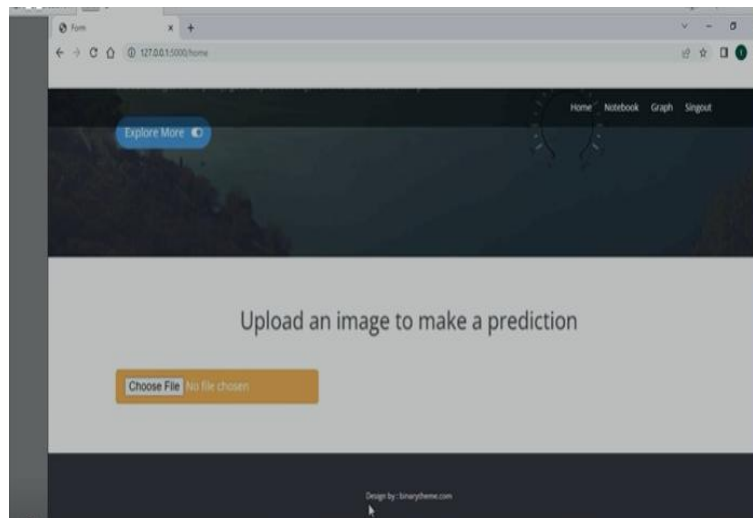

Fig.6: Main screen

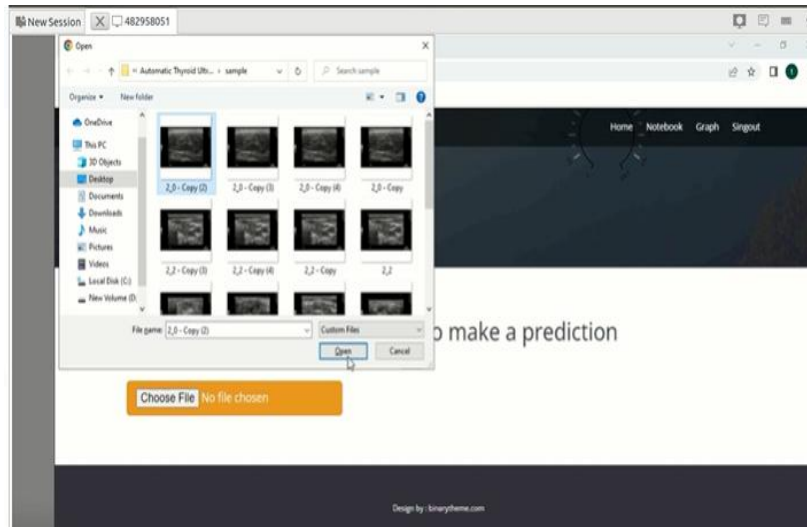

Fig.7: User input

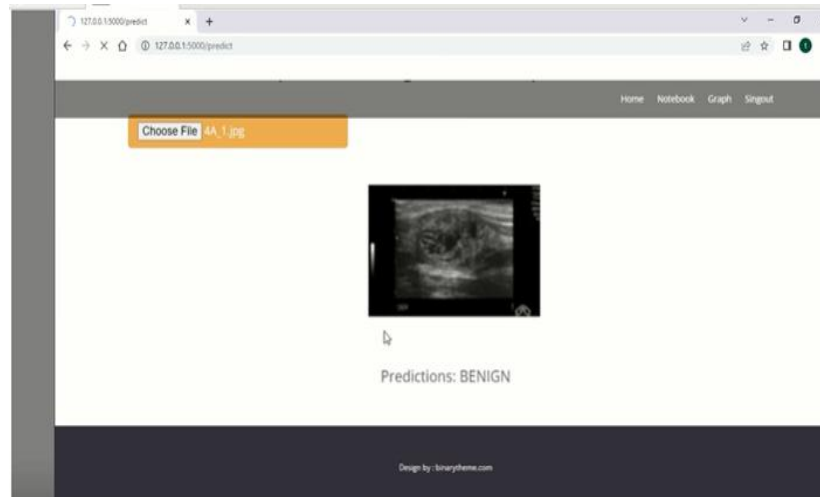

Fig.8: Prediction result

CONCLUSION

The reason for this examination is to help clinicians in making clinical determinations of thyroid handles, thus working on the exactness and speed of investigation. Ultrasound is an emotive and tedious methodology for clinically distinguishing protected and hurtful thyroid handles. Preprocessing clinical data, which includes managing, expanding, and extracting regions of interest, should be the first step. Then, making use of the connection between the component and the handle, feature planning is used to create the surface characteristics of the handles, taking into account the locality of the handles, and part dimensionality decreases. At long last, a significant frontal cortex network model is built, and texturea characteristics from the past stage are joined to further develop association execution in a general sense. In a study of 1874 thyroid-related patients, this method performed well, demonstrating clinical responsibility. A novel strategy for consolidating highlights that combines the advantages of component design with those of deep neural networks is presented in this study. No matter what the way that the primary job of this assessment is to endorse the definite demonstration of ultrasound imaging of thyroid handles, the exchange learning and mix highlight improvement might be used to various districts, including chest handles, lung handles, and other advancement separate. It is influential for note that the methodology of consolidating features is frequently utilized to add extra parts and information to deep neural networks, making it more straightforward and quicker for the association to join. Additionally, this is a potential future route for additional blend data. This review was prompted by the use of deep convolutional networks, image research, and PC-assisted determination.

REFERENCES

- [1]. J. Kim, J. E. Gosnell, and S. A. Roman, “Geographic influences in the global rise of thyroid cancer,” *Nature Rev. Endocrinol.*, vol. 16, no. 1, pp. 17–29, Jan. 2020.
- [2]. H. R. Shahraki, S. Pourahmad, S. Paydar, and M. Azad, “Improving the accuracy of early diagnosis of thyroid nodule type based on the SCAD method,” *Asian Pacific J. Cancer Prevention*, vol. 17, no. 4, pp. 1861–1864, Jun. 2016.
- [3]. J. Xu, M. Jing, S. Wang, C. Yang, and X. Chen, “A review of medical image detection for cancers in digestive system based on artificial intelligence,” *Expert Rev. Med. Devices*, vol. 16, no. 10, pp. 877–889, Oct. 2019.
- [4]. H. Ye, J. Hang, X. Chen, D. Xu, J. Chen, X. Ye, and D. Zhang, “An intelligent platform for ultrasound diagnosis of thyroid nodules,” *Sci. Rep.*, vol. 10, no. 1, Aug. 2020, Art. no. 13223.
- [5]. L. Wang, S. Yang, S. Yang, C. Zhao, G. Tian, Y. Gao, Y. Chen, and Y. Lu, “Automatic thyroid nodule recognition and diagnosis in ultrasound imaging with the YOLOv2 neural network,” *World J. Surg. Oncol.*, vol. 17, no. 1, p. 12, Jan. 2019.
- [6]. C. Chen, L. Zhan, X. Pan, Z. Wang, X. Guo, H. Qin, F. Xiong, W. Shi, M. Shi, F. Ji, Q. Wang, N. Yu, and R. Xiao, “Automatic recognition of auditory brainstem response characteristic waveform based on bidirectional long short-term memory,” *Frontiers Med.*, vol. 7, Jan. 2021, Art. no. 613708.
- [7]. D. Koundal, S. Gupta, and S. Singh, “Computer aided thyroid nodule detection system using medical ultrasound images,” *Biomed. Signal Process. Control*, vol. 40, pp. 117–130, Feb. 2018.
- [8]. D. Koundal, S. Gupta, and S. Singh, “Automated delineation of thyroid nodules in ultrasound images using spatial neutrosophic clustering and level set,” *Appl. Soft Comput.*, vol. 40, pp. 86–97, Mar. 2016.
- [9]. Y. Zheng, S. Xu, Z. Zheng, L. Wu, L. Chen, and W. Zhan, “Ultrasonic classification of
- [10]. multicategory thyroid nodules based on logistic regression,” *Ultrasound Quart.*, vol. 36, no. 2, pp. 149–157, Jun. 2020.
- [11]. W. Sun, S. Xie, J. Yu, L. Niu, and W. Sun, “Classification of thyroid nodules in ultrasound images using deep model based transfer learning and hybrid features,” in *Proc. IEEE Int. Conf. Acoust., Speech Signal Process. (ICASSP)*, Mar. 2017, pp. 919–923.